



Smart C+

Single-jet vane-wheel water meters
DN15, DN20

Smart C+

Smart C+ single-jet vane wheel water meter is designed for precise measurement of delivered water. Thanks to the newest construction solutions the water meter is adapted for installing the radio module which enables the remote reading of indications. It is the best secured vane-wheel water meter, resistant to the external magnetic field. The water meter is designed on the basis of the MID Directive with the indicating range corresponding the value of R=160 (previously named as C metrological class).

Hermetic counter (with a increased tightness) resistant to mist over

Protection against the external mechanical interference in the counting device, obtained by using the seal on the clamp and the guard with the element of external pressure detection

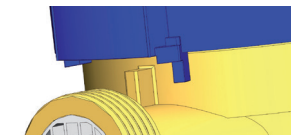

Interlock of the counting device rotation, with a higher rotation than the 360° angle

Very high resistance to the magnetic coupling, thanks to using the appropriate distance between spot face of the magnetic coupling

Bilaterally impeller bearing (with a usage of a high quality pivots and stone bearings) it ensures the running within the legalization period with saving the normative legalization parameters



The full resistance of the data transmission device to the external magnetic field achieved thanks to the retro-reflective pointer as an element of the optical data transfer from the water meter to the radio module

Very high resistance of the water meter Smart C+ to the activity of the external magnetic field SN+ resulting from using special magnetic screens

Very high resistance of the water meter Smart C+ to the activity of the external magnetic field SN+ resulting from using special magnetic screens

High resistance of the magnetic coupling to the activity of the external magnetic field by using double multi-field magnets

Strainer in the water meter inlet making the protection against any foulness which could get in the counting organ

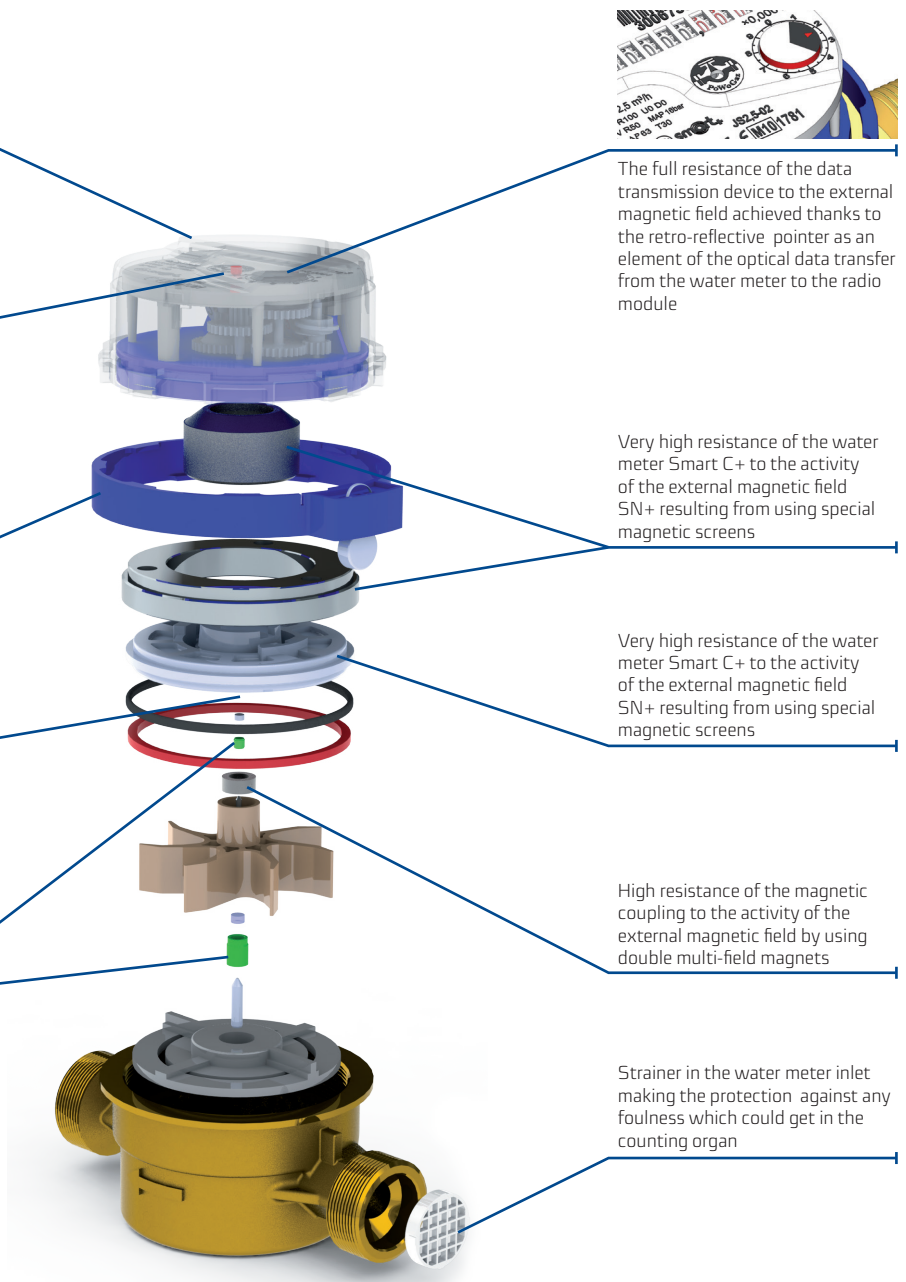

Usage

Cold water supply systems operating at temperatures up to 50°C or hot water supply systems operating at temperatures up to 90°C in single and multi-family housing. The rotating counter facilitates reading of the water meter in specified operating positions. For installation in horizontal piping with the counter upward (H↑) or to either side (H→) and in vertical piping with the counter sideways (V).



Water meter SMART C+

The standard water meter version is ready for RF/pulse/M-Bus modules

Advantages

Economy:

- Precise measurement:
 - factor R160 – H (previously named as C class according to GUM)
 - the highest resistance in the scale of the house single-jet vane-wheel water meters to the activity of the external magnetic field

Comfort of usage:

- adapted to the remote readings
- easy reading thanks to the possibility of free setting the rotating counter

Low running costs:

- tested and solid construction
- high running durability

Characteristic features

- Alarm signalization –the water meter is equipped with the radio module which has the possibility of informing about: de-installation or taking off the radio module, work interferences of the module, backflow, leaks etc.
- Easy readings thanks to:
 - hermetic counter resistant to mist,
 - readable numerals on barrels in two different colours which allow for an accurate reading,
 - counter 360° rotation.
- Protection against the mechanical interference through the use of the pin, which is deforming the counter's shield leaving the mark of the unapproved tamper.



Accordance with norms and regulations

- Directive 2004/22/WE of the European Parliament and of the Council dated at 31 March 2004 about the measuring instruments
- OIML R49: 2004 i 2006 – water meters meant for cold drinking water and hot water
- PN-EN-14154 :2011 – Wodomierze. Część 1 ÷ 3
- EN-14154:2011 – water meters part 1÷3
- Certificate of the WE examination- cold and hot water no. TCM 142/11-4832
- Classification of the environment, climatic and mechanic conditions - B class according to PN-EN-1454-3:2005:A1
- Classification of the environment and mechanic conditions - MI class - according to RMG from 18.12.2006
- Classification of the environment and electromagnetic conditions - E1 class - according to 18.12.2006

All the materials used in constructing the Smart C+ water meter have a Hygienic Certificate allowing the product to contact with drinking water.

Table 1. Technical data

Parameter			SMART C+			
			JS 1,6-02 JS90-1,6-02	JS2,5-02 JS90-2,5-02	JS2,5-G1-02 JS90-2,5-G1-02	JS4-02 JS90-4-02
Nominal diameter	DN	mm	15		20	
Permanent flow rate	Q_3	m ³ /h	1,6	2,5		4
Overload flow rate	Q_4	m ³ /h	2	3,125		5
Transitional flow rate	H R160	Q_2	dm ³ /h	25		40
	V R63			63		102
Minimal flow rate	H R160	Q_1	dm ³ /h	16		25
	V R63			40		63
Starting flow	–	–	dm ³ /h	5	6	12
Ratio Q_2/Q_1	–	–	–	1,6		
Temperature class (nominal temperature class)	–	–	–	T30 / T50 / T90		
Flow profile sensitivity classes	–	–	–	U0, D0		
Indicating range	–	m ³	–	99999		
Resolution of reading	–	m ³	–	0,00005		
Max pressure	P_{max}	MPa	–	1,6		
Max pressure los	Δp	kPa	–	63		
Advisable error in the scale of: $Q_2 \leq Q \leq Q_4$	ϵ	%	–	± 2 dla wody zimnej ± 3 dla wody ciepłej		
Advisable error in the scale of: $Q_1 \leq Q < Q_2$	ϵ	%	–	± 5		
Tightness class of the water meter counter	–	–	–	IP 65		
Dimensions	G	cal	G $\frac{3}{4}$	G $\frac{3}{4}$; G $\frac{7}{8}$	G1	G1
	H	mm	68,5			
	L	mm	110	110*	130	130
	D	mm	72			
Weight (without the connection elements)	–	kg	0,5	0,5	0,6	0,6

The water meter construction

-02 (with the 8 barrel counter, adjusted for the radio module installation)

* On special ordering are available over standard variants of the main casing thread (input and output) and the length L=115mm

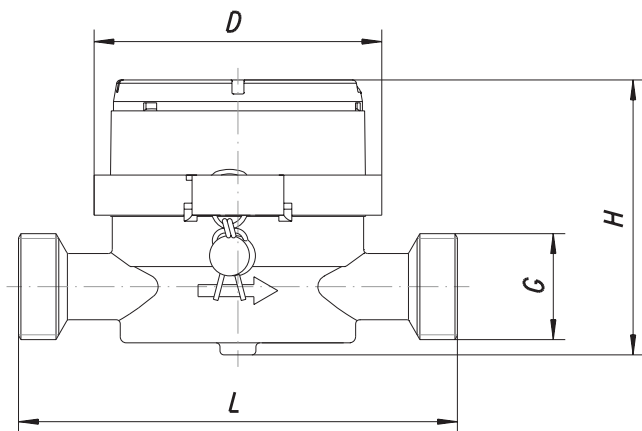

Connection elements

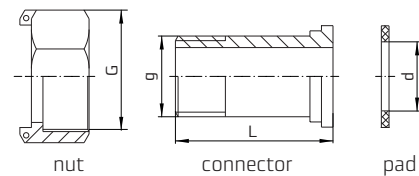

DN	G	g	d	L
	inch	inch	mm	mm
15	3/4	1/2	17	37,5
20	1	3/4	23	45,6

Pressure loss chart

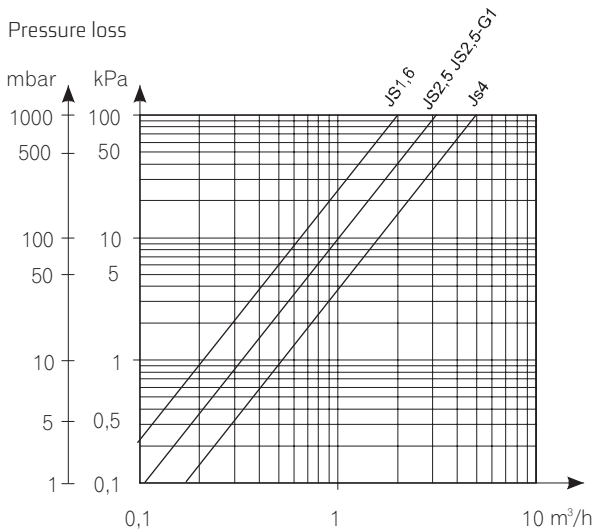

Typical error chart

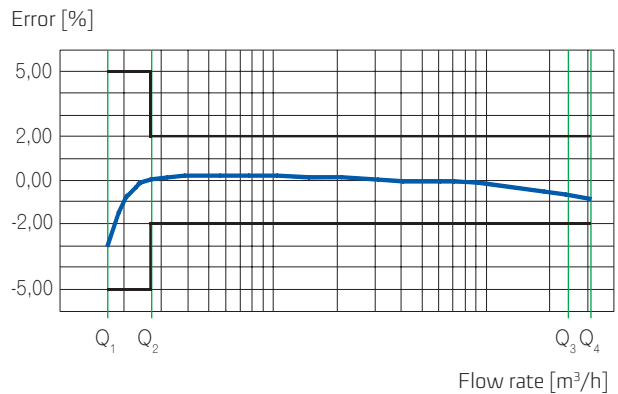

Example of remote reading data transmission

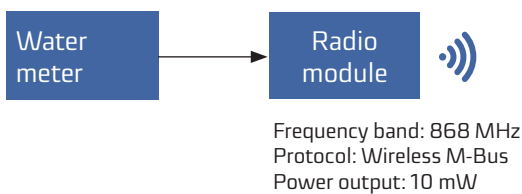

Example of order:

Water meter for i.e.

- cold water - water meter JS2.5-02 Smart C+
- hot water - water meter JS90-2,5-02 Smart C+

Over standard making of the water meter for example to

- hot water - water meter JS90-2,5-02 Smart C+ (¾" – 115 mm)

For additional order we deliver:

- coupling for the water meter, without the reflux valve
- coupling for the water meter, with the reflux valve (preventing the backing the indications of reading by the forced water flow in the opposite direction)
- expendable clapping rings with clasp lock seals made from plastic with the individual unique numeration (mechanical manipulation protection at the couplings of the water meter)

The data herein is current on the date of issue hereof.
The manufacturer has the right to modify and improve the products without notice.
This publication is indicative only and shall not be construed as a commercial offer under the Polish Civil Code.



Apator Powogaz SA

ul. Klemensa Janickiego 23/25, 60-542 Poznań

e-mail: handel.powogaz@apator.com

Office: phone +48 61 8418 101, fax: +48 61 8470 192

Sales: phone +48 61 8418 ext. 133 / 136 / 138 / 148

Export: phone +48 61 8418 139